



ADMIRAL
STAGING

Original user manual

FLEX RAMP®



Manufacturer:

Rolight Theatertechniek B.V.

Josink Kolkweg 10

7545 PR Enschede , The Netherlands

Phone (+31)53 432 06 44

info@rolight.nl

www.rolight.nl

Distributed by ADMIRAL

VERSION 01

May 2024

SKU: POURF100	POURP400
POURF110	POURP500
POURP125	POURP600
POURP200	POURP800
POURP300	

www.admiralstaging.com

CONTENT

1. INTRODUCTION
2. SAFETY INSTRUCTIONS
3. SCOPE
4. LIMITATIONS OF USE
5. TECHNICAL DATA & LOADCHART
6. IDENTIFICATION
7. EXPLANATION OF THE STICKERS
8. ASSEMBLY INSTRUCTIONS
9. DISASSEMBLY INSTRUCTIONS
10. STORAGE
11. MAINTENANCE & REJECTION CRITERIA
12. WARRANTY
13. MANUFACTURER'S DECLARATION OF CONFORMITY

1. INTRODUCTION

The ADMIRAL FLEX RAMP is a modular system which can be used to create access ramps. This modular system allows the construction of access ramps with different angles and landing heights. The platforms used to create the flooring are not part of the system and can be of different manufacturers. These platforms shall match the specifications given in this manual. For the ease of reading "FLEX RAMP" is used to replace wording of parts like "Flex Frame", "Flex Housing Set" and "Flex Legs".

For ramp configurations that require the use of a Flex Frame, please consult the original user manual "FLEX FRAME". It provides further instructions and guidance on assembling and maintaining the Flex Frame.

ADMIRAL has endeavoured to deliver the highest degree of accuracy possible. However continuous improvement of our products is ADMIRAL policy. Therefore product specifications are subject to change without notice.

Readers and users are encouraged to notify ADMIRAL of errors and send in suggestions for improvements. All communications will be carefully considered for future printings of this manual and changes to our products.

2. SAFETY INSTRUCTIONS

This user manual must be read and understood prior to assembly, setup and servicing. All people using and servicing the FLEX RAMP must familiarise themselves with the safety instructions and user guidelines written in this manual. This manual needs to be accessible for all users at all times.

LEGEND



DANGER

DANGER: Indicates a hazardous situation which, if not avoided, will result in death or serious injury. This signal word is to be limited to the most extreme situations.



WARNING

WARNING: Indicates a hazardous situation which, if not avoided, could result in death or serious injury.



CAUTION

CAUTION: Indicates a hazardous situation which, if not avoided, could result in minor or moderate injury.

NOTICE

NOTICE: Addresses practices not related to personal injury.

SAFETY INSTRUCTIONS

SAFETY INSTRUCTIONS: Is used for lists of steps, procedures or instructions that might otherwise substitute a DANGER, WARNING or CAUTION notification. Note that equivalent phrases, such as SAFE OPERATION PROCEDURES or SAFE SHUT DOWN PROCEDURE, can be used in place of the words "SAFETY INSTRUCTION".



CAUTION

DO NOT install the FLEX RAMP without the following precautions:

- A FLEX RAMP must be taken out of service immediately if, during use, repair or maintenance damages are discovered.
- Remove people from the area during installation.
- Use solely instructed and/or trained personnel.
- Wear appropriate Personal Protective Equipment (PPE) such as hard hats and gloves during installation.
- Make sure there is adequate amount of working light during the installation of the product.
- Always install the FLEX RAMP with 2 or more persons.

3. SCOPE

The intended use of the FLEX RAMP system is to construct a stage ramp of specific, pre-determined height, length and angle. The maximum working load is 500 kg/m². The ramps can be used to roll goods like flightcases, loudspeakers and lighting equipment from floor level up to stage level.

The FLEX RAMP shall always be used in combination with a stage of minimum 6 x 4 m (24m²) in order to provide the required longitudinal stabilisation. The FLEX RAMP system is not designed to be used for general public access applications.

Any other way of use then mentioned is considered to be a case of misuse. Solely the user is liable for any damage or injury resulting from such cases.



WARNING

Check local legislation for the application of use.

4. LIMITATIONS OF USE



WARNING

Exceeding the limitations of use can severely endanger the audience and users.

- The FLEX RAMP can be used with stage decks that have a minimum load capacity of 500kg/m² with an allowable lateral load of 5%. The centre-to-centre of the leg pockets shall be 148 mm less than the width and length of the staging platforms. The leg pocket shall be suitable to adapt 48 mm round legs.
- The FLEX RAMP shall always be used in combination with a stage of minimum 6 x 4 m (24m²).
- The FLEX RAMP can be operated from -20° up to 60° Celsius.
- Do not exceed the maximum working load of 500 kg/m² stated on the product.
- The FLEX RAMP can be used to build ramps from 0 cm up to 180 cm depending on the type of legs used.
- Users must use a handrail at both sides of the ramp. The railing must be able to withstand a minimum of 30 kg/m.
- The FLEX RAMP must be inspected by a competent person as often as required but with a minimum of 1 x per year. Records of these inspections must be kept.
- Inspect equipment before every use. A damaged FLEX RAMP shall be taken out of service.
- Outdoor use shall be approved by a competent person and might influence the load capacity. Do not expose the product to full rain or snow. Outdoor use is the sole responsibility of the user.
- In case of use in the vicinity of saltwater, the product shall be rinsed regularly with fresh water to avoid corrosion.
- It is also imperative to observe the local accident prevention regulations and/ or occupational health and safety regulations.
- Make sure the FLEX RAMP is dry and free of dirt.
- Use appropriate packaging to transport the products. e.g. a flightcase.
- Solely use by ADMIRAL approved parts to replace damaged or lost parts.
- Do not re-zinc steel components as they might be subject to hydrogen embrittlement.
- The Flex Ramp is compatible with decks from Prolyte, Nivtec, Innodeck and Sixty82 Stage 82. Please note that Eurotruss decks are not compatible with the Flex Ramp.

WARNING

Dynamic loads, such as “moving vehicles”, are not allowed.

WARNING

Users must use a handrail at both sides of the ramp.

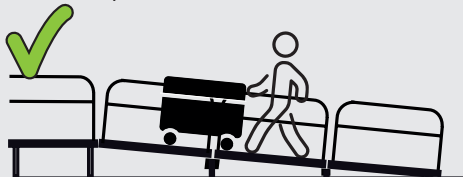

Slippery when wet.

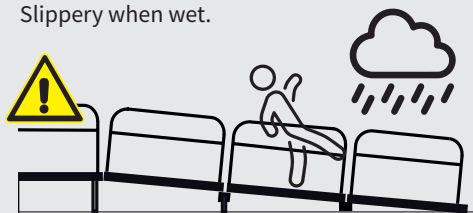

WARNING

The maximum stage height at which the FLEX RAMP can be used is 180 cm (a).

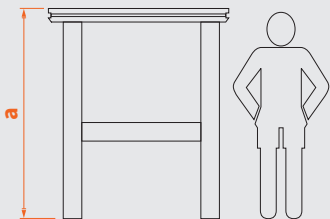

Follow the instructions in the Flex calculator app to determine the number of decks that shall be used for each specific height.

WARNING

Do not use the FLEX RAMP without a stage. The FLEX RAMP is NOT a standalone unit.



No dynamic loads (such as e.g. cars).

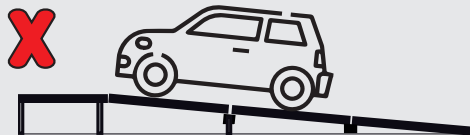

Always use the FLEX RAMP on a flat surface.

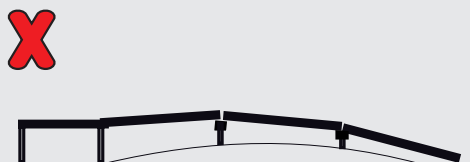

CAUTION

Do not throw the FLEX RAMP parts, as it might damage the products.

WARNING

Make sure the legs are not placed crookedly (fig 01), but vertical at all times (fig 02).

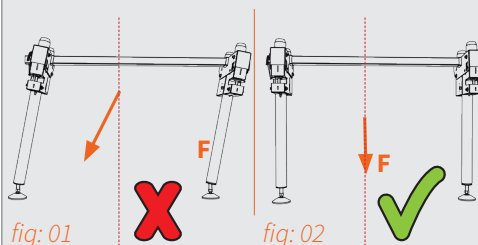

5. TECHNICAL DATA & LOADCHART

Flex Leg

Technical data

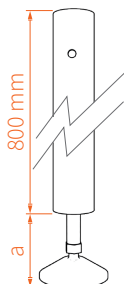
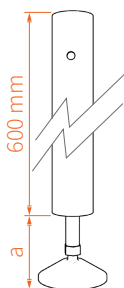
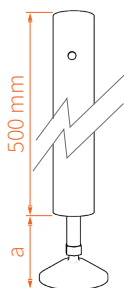
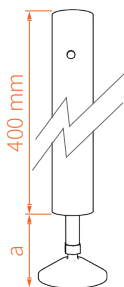
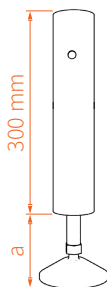
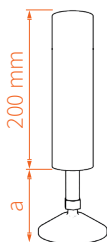
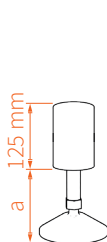

Top view

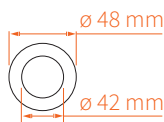

Article code:	POURP125
EAN:	8720094420226
Max load*:	500 kg/m ²
Material:	aluminium
Colour:	silver
Dimensions:	125 x ø 48 mm (L x D)
Feet (a)	30/120 mm min/max
Weight:	0.6 kg

POURP200
8720094420288
500 kg/m ²
aluminium
silver
200 x ø 48 mm (L x D)
30/120 mm min/max
0.7 kg

Article code:	POURP300
EAN:	8720094420233
Max load*:	500 kg/m ²
Material:	aluminium
Colour:	silver
Dimensions:	300 x ø 48 mm (L x D)
Feet (a)	30/120 mm min/max
Weight:	0.8 kg

POURP400
8720094420240
500 kg/m ²
aluminium
silver
400 x ø 48 mm (L x D)
30/120 mm min/max
0.9 kg

Article code:	POURP500
EAN:	8720094420257
Max load*:	500 kg/m ²
Material:	aluminium
Colour:	silver
Dimensions:	500 x ø 48 mm (L x D)
Feet (a)	30/120 mm min/max
Weight:	1.0 kg kg

POURP600
8720094420271
500 kg/m ²
aluminium
silver
600 x ø 48 mm (L x D)
30/120 mm min/max
1.2 kg

Article code:	POURP800
EAN:	8720094420356
Max load*:	500 kg/m ²
Material:	aluminium
Colour:	silver
Dimensions:	800 x ø 48 mm (L x D)
Feet (a)	30/120 mm min/max
Weight:	1.4 kg kg

* Max load is calculated in combination with a stage of 6 x 4 m minimum and not as a stand alone structure.

Flex Housing Set

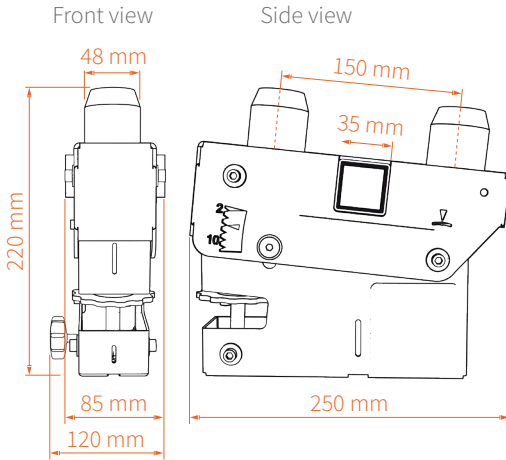

Technical data

Article code:	POURF110
EAN:	8720094420264
Max load*:	500 kg/m ²
Material:	House: steel
	Brace: steel
Colour:	House: silver
	Brace: orange
Dimensions:	House: 250 x 60 x 220 mm (L x W x H)
	Brace: 35 x 35 x 990 mm (L x W x H)
Weight:	10.1 kg

* Max load is calculated in combination with a stage of 6 x 4 m minimum and not as a stand alone structure.

Flex Brace

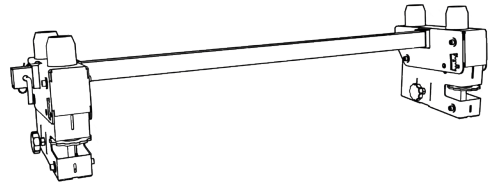
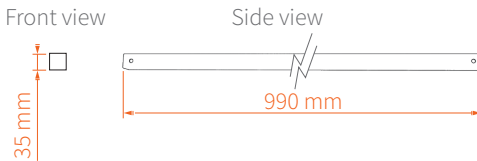

The set includes two Flex House elements and a Flex Brace.

Flex Frame

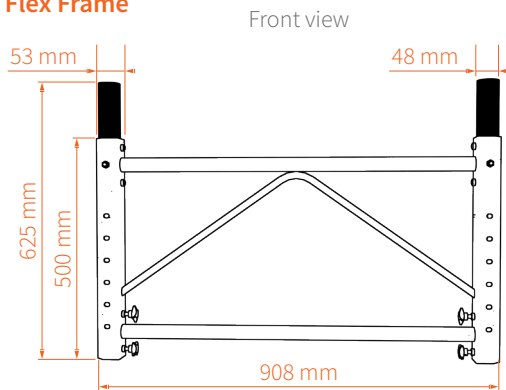

Technical data

Article code:	POURF100
EAN:	8720094420219
Max load*:	500 kg/m ²
Material:	steel
Colour:	silver
Dimensions:	910 x 625 x 55 mm
Weight:	5.6 kg

* Max load is calculated in combination with a stage of 6 x 4 m minimum and not as a stand alone structure.

Combinations/possibilities

Stage height 100 cm - 3 decks

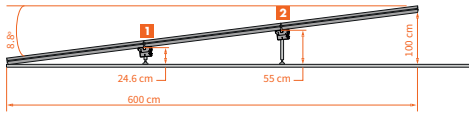

Stage height 120 cm - 4 decks

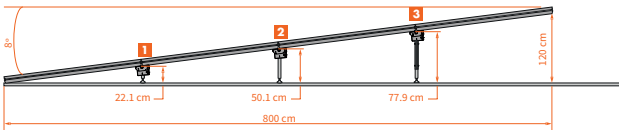

Stage height 160 cm - 5 decks

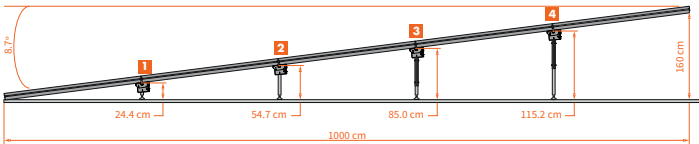

Scan the QR code to see all the possibilities in the FLEX RAMP calculator.

Products needed

1 First position

- 1x POURF110 - Flex Housing set
- 2x POURP200 - Flex Leg H 200 mm

2 Second position

- 1x POURF110 - Flex Housing set
- 2x POURP500 - Flex Leg H 500 mm

+ Total amount of products

- 2x POURF110 - Flex Housing set
- 2x POURP200 - Flex Leg H 200 mm
- 2x POURP500 - Flex Leg H 500 mm

1 First position

- 1x POURF110 - Flex Housing set
- 2x POURP125 - Flex Leg H 125 mm

2 Second position

- 1x POURF110 - Flex Housing set
- 2x POURP400 - Flex Leg H 400 mm

3 Third position

- 1x POURF110 - Flex Housing set
- 2x POURP400 - Flex Leg H 400 mm
- 1x POURF100 - Flex Frame H 500 mm

+ Total amount of products

- 3x POURF110 - Flex Housing set
- 2x POURP125 - Flex leg H 125 mm
- 4x POURP400 - Flex leg H 400 mm
- 1x POURF100 - Flex Frame H 500mm

1 First position

- 1x POURF110 - Flex Housing set
- 2x POURP200 - Flex Leg H 200mm

2 Second position

- 1x POURF110 - Flex Housing set
- 2x POURP500 - Flex Leg H 500 mm

3 Third position

- 1x POURF110 - Flex Housing set
- 2x POURP400 - Flex Leg H 400 mm
- 1x POURF100 - Flex Frame H 500 mm

4 Fourth position

- 1x POURF110 - Flex Housing set
- 2x POURP600 - Flex Leg H 600 mm
- 1x POURF100 - Flex Frame H 500 mm

+ Total amount of products

- 4x POURF110 - Flex Housing set
- 2x POURF100 - Flex Frame H 500mm
- 2x POURP200 - Flex leg H 200 mm
- 2x POURP400 - Flex leg H 400 mm
- 2x POURP500 - Flex leg H 500 mm
- 2x POURP600 - Flex leg H 600 mm

Applicable Directives, Regulations, Standards and Information Papers

The following standards and information papers are used

EN 1990 Eurocode	Basis of structural design
EN 1991 Eurocode 1	Actions on structures
EN 1993-1-1 Eurocode 3	Design of steel structures
EN 1999-1-1 Eurocode 9	Design of aluminium structures
EN 17736	Specifies the requirements for the design and manufacture of aluminium decks and frames used in the entertainment industry

6. IDENTIFICATION

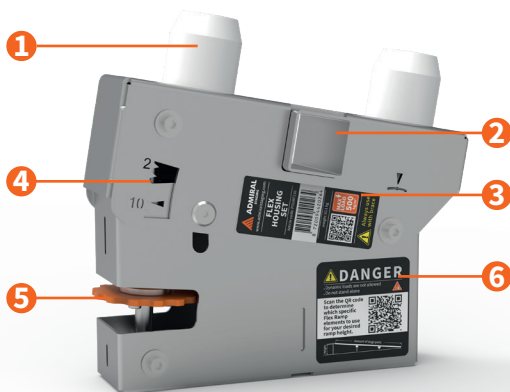

Flex House

- 1 Adjustment knob
- 2 Gap for brace tube
- 3 Product sticker (A)
- 4 Slope pointer
- 5 Adjustment wheel
- 6 Information sticker (B)

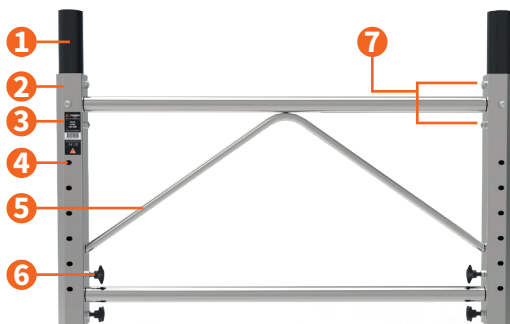

Flex Frame

- 1 Tube
- 2 Frame
- 3 Product sticker
- 4 Height adjustment holes
- 5 Stabilisation bar
- 6 Tightening knobs
- 7 Adjustment screw



Flex Leg

- 1 Leg
- 2 Fixation hole
- 3 Product sticker
- 4 Adjustable foot

7. EXPLANATION OF THE STICKERS

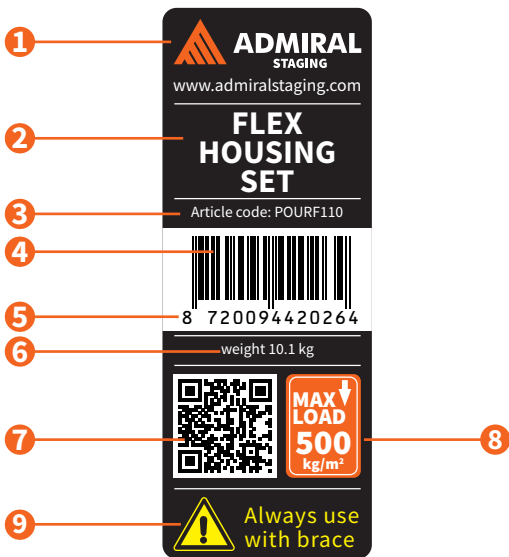

Flex House sticker A

- | | |
|----------------|----------------------------|
| 1 Brand name | 6 Weight |
| 2 Product name | 7 QR code to online manual |
| 3 Article code | 8 Max load |
| 4 Barcode | 9 Brace use warning |
| 5 EAN code | |



Flex House sticker B

- 1 Warning sign
- 2 Conditions of use
- 3 Explanation QR code
- 4 Schematic representation of a stage assembly
- 5 Read the manual
- 6 QR code to the Ramp Calculator

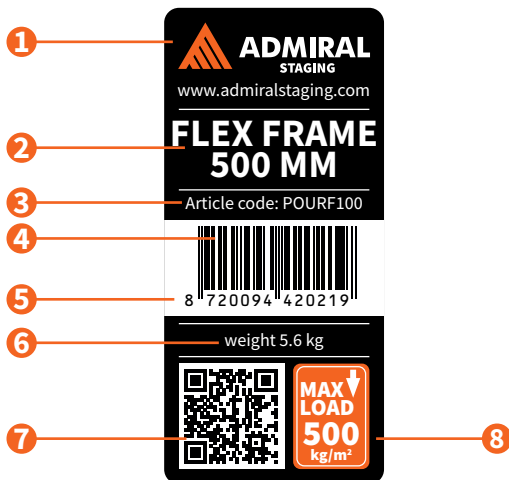

Flex Frame

- | | |
|----------------|----------------------------|
| 1 Brand name | 5 EAN code |
| 2 Product name | 6 Weight |
| 3 Article code | 7 QR code to online manual |
| 4 Barcode | 8 Max load |

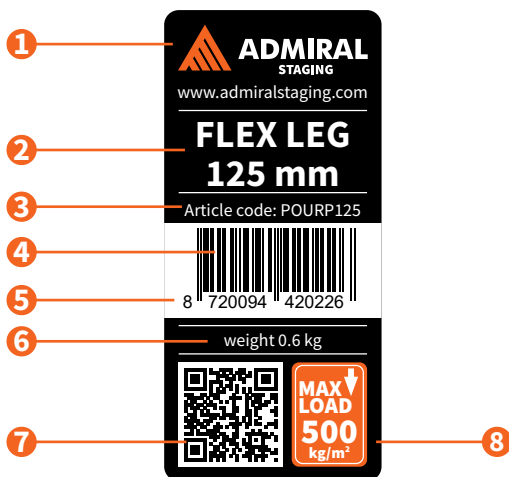

Flex Leg

- | | |
|----------------|----------------------------|
| 1 Brand name | 5 EAN code |
| 2 Product name | 6 Weight |
| 3 Article code | 7 QR code to online manual |
| 4 Barcode | 8 Max load |

8. ASSEMBLY INSTRUCTIONS

CAUTION
Use 2 persons for set up.

WARNING
Inspect the FLEX RAMP before use. Make sure all components are in place and in good order. If damaged, mark the item clearly and take out of service.

NOTICE
We recommend not exceeding a slope of 9° when loading heavier equipment.

WARNING
A FLEX RAMP higher than 70 cm needs to be built up with a Flex Frame.

Step 1
Scan the QR code to open the FLEX RAMP calculator.



TIP
By changing the amount of stage decks the slope will vary. Choose the amount of stage decks depending on the desired slope.

- A** Enter the height of the stage
- B** Enter the amount of stage decks

As a result you get a drawing and the slope which you require in Step 2. Depending on the setup, on some positions you have to insert the Flex Legs into the stage deck without the Flex Housing Set.

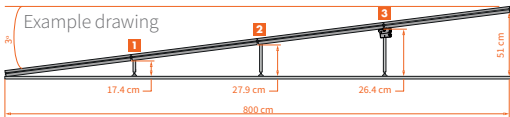

Step 2
Turn the orange adjustment wheel (a) to set the slope (b) on each Flex House as shown in the calculator.

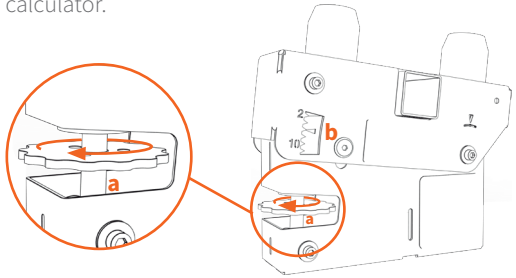

NOTICE
The values should be set as accurately as possible. After installing the FLEX RAMP, you can fine tune the height by using either the adjustment wheel or the spindle feet.

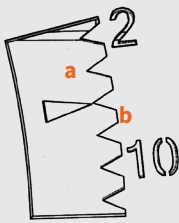

The points (a) are the even numbers while the blunt points (b) are the odd numbers.

Step 3
Assemble the two Flex House elements and the Flex Brace and secure the Flex Brace on both ends with the safety pins (a).

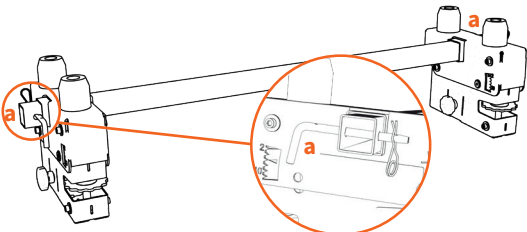

NOTICE
To assemble a ramp using a Flex Frame, follow the instructions provided in the section labeled “In case of using the Flex Frame” at the end of this chapter.

Step 4

Set each leg to the correct length as indicated on the drawing by turning the spindle.

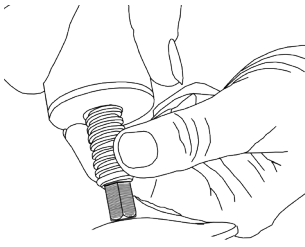

CAUTION

Do not put the foot spindle all the way in.

Step 5

Insert the Flex Leg (a) in the pre-set Flex Housing (b).

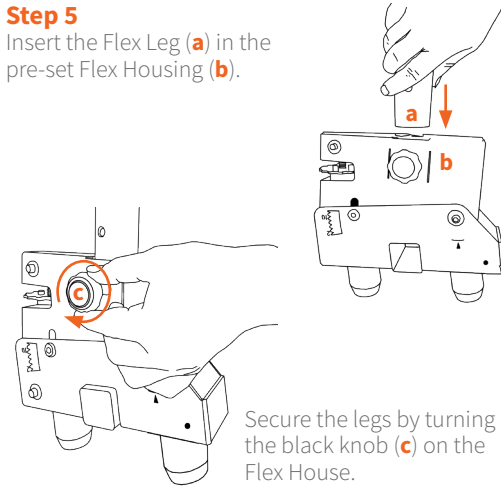

Secure the legs by turning the black knob (c) on the Flex House.

NOTICE

Start building the FLEX RAMP from top (the stage) to the bottom (ground).

Step 6

Insert the deck-to-deck profile into the stage deck at the position where you want to build the FLEX RAMP. Make sure the hook (a) of the profile points upward.

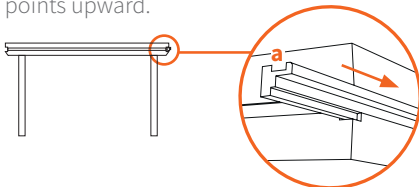

Step 7

Place each stage deck on its side. Insert the FLEX RAMP in the leg pocket of the decks and secure the leg pocket.

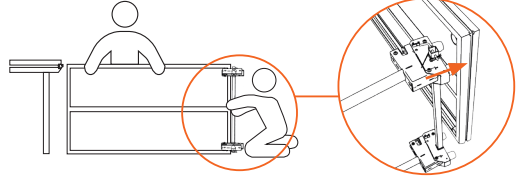

WARNING

Make sure the leg pocket clamp (a) is secured after the FLEX RAMP is mounted.

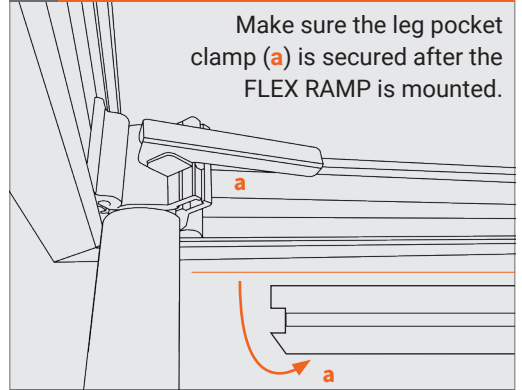

WARNING

Insert the Flex Housing Set and Flex Legs with the Adjustment wheel (a) pointing to the stage.

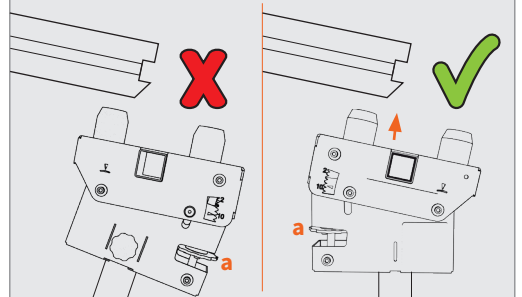

Step 8

Hook the first stage deck (a) in place on the stage (b).

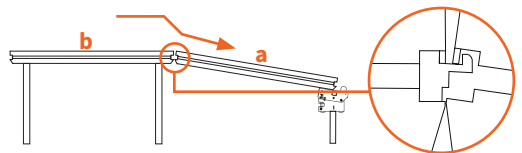

Step 9

Lift the second stage deck on the remaining knob of the Flex Housing Set and secure it with the leg pocket clamp.

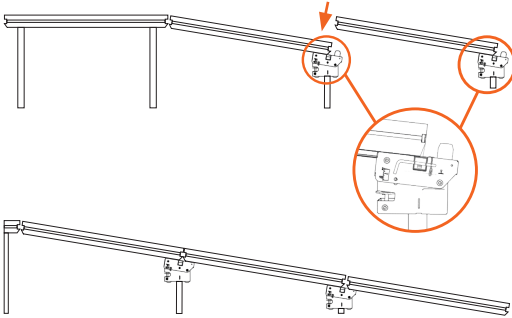

TIP

Repeat this step until all the decks are in place.

Step 10

Hook the ADMIRAL RAMP SLOPE (not included) to the last stage deck for a smooth finish.

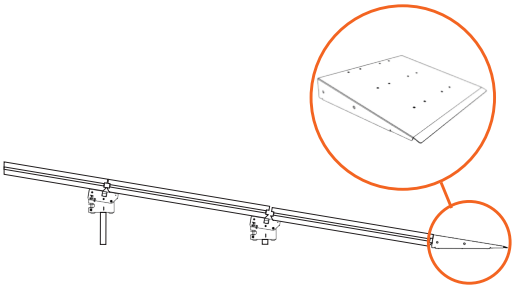

WARNING

At lower slopes, it is possible that only a Flex Leg is necessary. In this case insert the Flex Leg in the stage deck and use a deck-to-deck profile to lock both decks together.

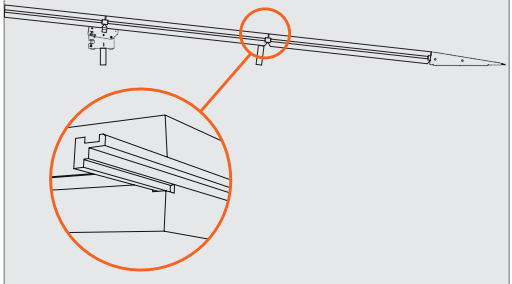

In case of using the Flex Frame

WARNING

Refer to the Flex Frame manual for instructions on how to set up the Flex Frame.

Step 1

Turn the Flex Frame upside down and place the Flex Leg (a) into the Flex Frame (b). Fasten the Flex Leg securely within the Flex Frame by inserting the locking pin through the nearest hole on the Flex Frame that can achieve the desired total height (c).

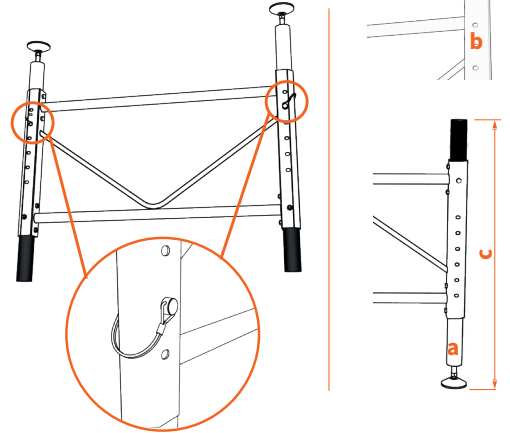

Step 2

Reverse the Flex Frame and adjust the feet spindle (d) as necessary to reach the correct total height (c).

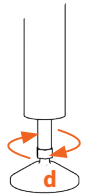

Step 3

Tighten the Flex Leg by fastening the four black knobs in the appropriate holes.

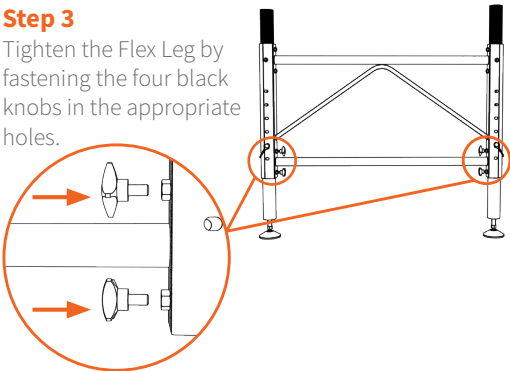

Step 4

Lay the Flex Housing Set upside down on the ground and press the Flex Frame construction into the Flex Houses.

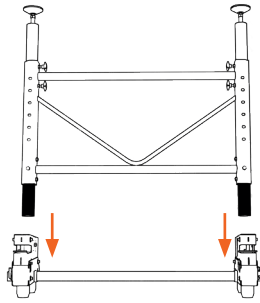
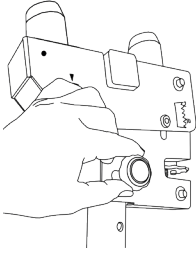

Secure the construction by tightening the black knobs on the Flex Houses.

Step 5

Place the stage deck on its side and insert the assembled FLEX RAMP in the decks. Secure the FLEX RAMP with the leg pocket clamp.

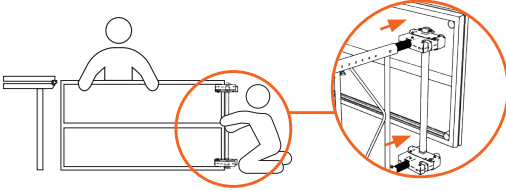

9. DISASSEMBLY INSTRUCTIONS

Step 1

Remove the RAMP SLOPE (a).

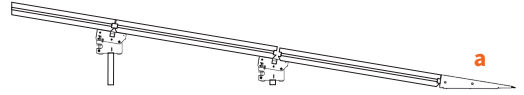

Step 2

Disassemble the decks one by one.



Step 3

Remove the different FLEX RAMP elements (Flex Housing Set, Flex Legs and Flex Frame) and put them in a crate or box for storage.

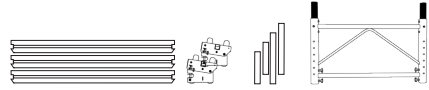

10. STORAGE

The FLEX RAMP must be stored in a dry, non-aggressive environment.

- Make sure the parts cannot bend.
- Avoid vibrations. Rubbing parts can cause excessive wear and tear.

11. MAINTENANCE & REJECTION CRITERIA

SAFETY INSTRUCTIONS

The FLEX RAMP hardly needs any maintenance under normal use and environmental circumstances.

For safety reasons however, all parts must be checked regularly for dirt, damages, loss and corrosion.

The FLEX RAMP shall be checked in compliance with the local law by a competent person. Checking shall take place as often as required but with a minimum of 1x per year. In case of doubt contact ADMIRAL.



WARNING

If damaged, mark the item clearly and take it out of service.

- Missing or damaged components should be replaced by genuine ADMIRAL components only.
- Check all components for damages like cracks, deformations, scratches and corrosion. Damaged and corroded parts shall be rejected and thrown away.
- The threaded parts of the Flex Legs should be maintained with periodical lubrication.
- In general, scratches > 10% of the wall thickness mean the products needs to be rejected from use.
- In general, deformations > 10% of a straight line from the outer surface mean the products needs to be rejected from use.
- Remove all sharp and rough feeling edges and surfaces by using sand paper or a file.
- Check roll pins and welds for cracks. If cracked, replace.

12. WARRANTY

- For a period of 24 months we will repair, free of charge, any damage attributable to faulty materials or workmanship under the condition that the equipment is forwarded, freight paid, to our warehouse or one of the ADMIRAL distributors' warehouses.
- The warranty-period begins with the day of the delivery, proven by a purchase receipt like an invoice or delivery note or their copies.
- The warranty does not cover damage due to transport, negligent handling, overloading the equipment or parts subject to normal wear and tear signs. Nor damages that originate from a case of misuse because of nonobservance of the safety regulations in this instruction manual.
- The warranty will be invalid when other parts than the original ADMIRAL parts have been used or modifications of our design have been made by third parties.
- Warranty repairs do not renew nor extend the warranty-period.
- In case of a claim that falls under the warranty, e.g. a malfunction or spare part requirements please contact your point of sale or ADMIRAL.
- The manufacturer is not liable for indirect consequential damage and financial loss.
- The manufacturer shall not be liable for any changes made to the FLEX RAMP parts nor for any damage resulting from such changes.

13. MANUFACTURER'S DECLARATION OF CONFORMITY



MANUFACTURER'S DECLARATION OF CONFORMITY

Rolight Theatertechniek
Josink Kolkweg 10
7545 PR Enschede
The Netherlands

Herewith declares that:

ADMIRAL "FLEX RAMP" structure build with productes where codes starting with POUR****

- EN 1990 Eurocode: Basis of structural design
- EN 1991 Eurocode 1: Actions on structures
- EN 1993-1-1 Eurocode 3: Design of steel structures
- EN 1999-1-1 Eurocode 9: Design of aluminium structures
- EN 17736 Specifies the requirements for the design and manufacture of aluminium decks and frames used in the entertainment industry

Enschede , The Netherlands 24-June-2024

Ms. E. Dijk
Owner Rolight Theatertechniek b.v.



Rolight

